



www.unicahome.com
1-888-89-UNICA

Combinazioni modelli & tessuti / Grid of models & fabrics

 **TIRELLA TESSUTI CONSIGLIATA**
SUGGESTED FABRIC HANGER

Il numero rosso indica lo specifico tessuto sconsigliato all'interno della tirella.
The number of fabric within the fabric hanger shown in red, is not recommended.

 **TIRELLA TESSUTI SCONSIGLIATA**
NOT RECOMMENDED FABRIC HANGER

Il numero verde indica lo specifico tessuto consigliato all'interno della tirella.
The green numbers show the suggested specific fabrics within the fabric hanger.

 **TIRELLE SENZA INDICAZIONI SPECIFICHE**
NO SPECIFIC INSTRUCTIONS

E' necessario prestare attenzione alle indicazioni tecniche e sartoriali riportate sulle stesse.
Please refer to labels shown on the fabric samples.

- 92 Polyrock
- 95 Floribunda I **4**
- 104 Net - Work **1/9/11**
- Divina - Divina Melange
- Tonus
- Hallingdal
- Pelle T / Leather T
- Pelle Z / Leather Z

- 73 Grainderiz
- 81 Uniforms
- 87 Washables
- 90 Superwhites
- 91 FIT
- 93 Remix **3/5/7**
- 96 Floribunda II
- 97 Metropolitan
- 98 Hip Bazaar
- 99 Structures **bergen wave**
- 100 Cross Over 1
- 101 Cross Over 2
- 102 The Specials **7/6/3**
- 103 My Tip

- 71 Mohair & Velluti / Velvets
- 94 Timeless
- 4,8 only cushion
- Stamskin Top - Extrema
- Alcantara

Per qualsiasi richiesta particolare non prevista, si prega di contattare il Ns Ufficio commerciale.
For specific questions or requests, please contact your sales rep. or our sales office in Italy.

Prove tecniche / Technical test / Technische Proben / Essais Techniques

Fjord barra / Fjord beam / Fjord modular System / Fjord poutre

- EN1728:2000 clause 6.2.1.....Max level 5
- EN1728:2000 clause 6.2.2.....Max level 5
- EN1728:2000 clause 6.7.....Max level 5

Fjord poltrona girevole / Fjord swivel armchair / Fjord Drehsessel / Fjord fauteuil pivotant

- EN1728:2000 clause 6.2.1.....Max level 5
- EN1728:2000 clause 6.2.2.....Max level 5
- EN1728:2000 clause 6.7.....Max level 5

Fjord poltrona Relax / Fjord armchair Relax / Fjord Sessel Relax / Fjord fauteuil Relax

- UNI 8591/84.....Max level 5
- UNI EN 1022/98.....non si sbilancia
- EN1728:2000 clause 6.7.....Max level 5

ITALIANO		ENGLISH		DEUTSCH		FRANCAIS	
----------	--	---------	--	---------	--	----------	--

A Rivestimento		A Cover		A Bezug		A Revêtement	
sedile interno	schienale esterno	internal part the seat	external part the back	Sitzflaeche innen	Rücken aussen	intérieur l'assise	extérieur le dossier
	tessuto		fabric		Stoff		tissu
tessuto	pelle	fabric	leather	Stoff	Leder	tissu	cuir
pelle	tessuto	leather	fabric	Leder	Stoff	cuir	tissu
tessuto	tessuto	fabric	fabric	Stoff	Stoff	tissu	tissu
pelle	pelle	leather	leather	Leder	Leder	cuir	cuir

B Rivestimento		B Cover		B Bezug		B Revêtement	
fianco esterno	piano superiore	external side	upper part	Seiten aussen	Sitzfläche	bord externe	partie supérieure
tessuto	pelle	fabric	leather	Stoff	Leder	tissu	cuir

C Cuciture		C Sewings		C Nähte		C Coutures	
varianti	abbinamento	available col.	coupling	Varianten	Zuordnung	couleurs	assortiment
bianco		white		weiss		blanc	
nero		black		schwarz		noir	
rosso		red		rot		rouge	
in tinta	schienale est.	same colour	external back	gleiche Farbe	Rücken aussen	même couleur	dossier ext.
fuori standard	da specificare	out of standard	to be specified	Sonderanfertig.	Angeben	hors standard	à spécifier

D Cuciture		D Sewings		D Nähte		D Coutures	
varianti	abbinamento	available col.	coupling	Varianten	Zuordnung	couleurs	assortiment
bianco		white		weiss		blanc	
nero		black		schwarz		noir	
rosso		red		rot		rouge	
in tinta	fianco esterno	same colour	external side	gleiche Farbe	Seiten aussen	même couleur	bord externe
fuori standard	da specificare	out of standard	to be specified	Sonderanfertig.	Angeben	hors standard	à spécifier

E basamento		E base		E Gestell		E base	
varianti		available col.		Varianten		couleurs	
bianco		white		weiss		blanc	
nero		black		schwarz		noir	
rosso		red		rot		rouge	
grigio alluminio		aluminium grey		grau Aluminium		gris aluminium	
canna di fucile		rifle brown		Kanonengrau		gris fusil	



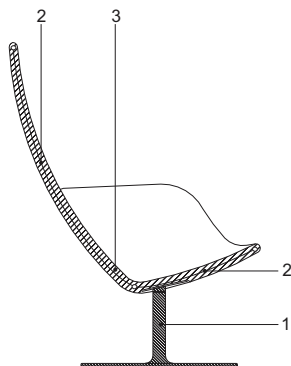

Legenda - Description	Struttura	Structure	Struktur	Structure
<p>1 Base girevole in acciaio Swivel base is steel Drehbares untergestell aus Stahl Base pivotante en acier</p> <p>2 Struttura in acciaio Steel frame Stahlstruktur Structure en acier</p> <p>3 Schiuma poliuretanic flessibile con densità 60 Kg/m3 Flexible polyurethane foam 60 Kg/m3 Flexibler polyurethanschaum 60 Kg/m3 Mousse en polyuréthane flexible a 60 Kg/m3</p>	<p>Espanso schiumato a freddo ignifugo con struttura in acciaio per le poltrone e sgabelli e in materiale plastico composito per le scocche delle poltroncine e barre. Le poltrone (cod.03K, 0V6 e 0V8) hanno la base quadrata.</p> <p>POUF (cod. 214-017-077): guscio in plastica antiurto, termoformata di colore nero.</p> <p>BARRE: struttura portante in acciaio verniciato canna di fucile. Piedi in fusione di alluminio lucidato con tavolo in laminato HPL di colore bianco o nero opaco.</p> <p>TAVOLI 0S1 - 06P: base quadrata in acciaio verniciato grigio alluminio o nero con piano in MDF nobilitato bianco.</p> <p>TAVOLI 0SA - 0S2: base in acciaio verniciato bianco o nero opachi con piano in MDF laccato bianco o nero lucidi.</p>	<p>Injected flame-retardant cold foam over internal steel frame. Codes 105-110 and beam seating: injected cold foam over technopolymer composite shell. Chairs (cod.03K, 0V6 and 0V8): swivel base has square footplate.</p> <p>FOOT STOOLS (cod. 214-017-077): Shell is shock-absorbant black plastic.</p> <p>BEAMS: Frame is tubular steel with rifle brown varnish. Feet are polished cast aluminum. Table is white or black HPL.</p> <p>TABLES 0S1 - 06P: Square base is steel with aluminium grey or black varnished finish. Tabletop is white plastic over MDF.</p> <p>TABLES 0SA - 0S2: Base is steel with white or black varnished finish. Tabletop is MDF with white or black glossy lacquer finish.</p>	<p>Stahlgestell in feuerhemmendem kaltgeschäum. Codes 105-110 und Modular System, Technopolymer in Schichtverfahren Schale kaltgeschäum. Sessel (Kod.03K, 0V6 und 0V8) haben eine quadratische Fussplatte.</p> <p>HOCKER (Kode 214-017-077): Kunststoffschale schwarz stofffest.</p> <p>MODULAR SYSTEM: Untergestell in Stahl Kanonengrau lackiert. Fuesse in Druckguss Aluminium. Tisch in HPL weiss oder schwarz.</p> <p>TISCHEN 0S1 - 06P: Untergestell viereckig aus Stahl lackiert aluminiumgrau oder schwarz. Tischplatte MDF umhüllt in Plastik Weiss.</p> <p>TISCHE 0SA - 0S2: Untergestell Stahl lackiert Weiss oder Schwarz. Tischplatte in MDF Weiss oder Schwarz hochglanz lackiert.</p>	<p>Acier enrobée dans mousse ignifugée injectée a froid. Technopolymer enrobée dans mousse injectée a froid pour les codes 105-110 et les poutres. Fauteuils (cod.03K,0V6 et 0V8) ont la base carré.</p> <p>POUFS (code 214-017-077): coquille en plastic anti-choc couleur noir.</p> <p>POUTRES: acier vernis gris fusil. Les pieds sont en aluminium brillant. Table en HPL blanc ou noir.</p> <p>TABLES 0S1 - 06P: base carré en acier vernis gris aluminium ou noir. Plateau en MDF revetu en plastique blanc.</p> <p>TABLES 0SA - 0S2: base en acier vernis blanc ou noir. Plateau en MDF laqué blanc ou noir brillante</p>
	<p>Sovraprezzi E' possibile a richiesta montare sulla poltroncina (cod.106) il basamento in inox 316 L con una maggiorazione di .</p>	<p>Surcharge With upcharge of armchair (code 106) base is also available in stainless steel 316 L.</p>	<p>Aufpreis Auf Anfrage, mit einem Aufpreis von kann das Untergestell des Sessel (Kode 106) in Edelsthal 316 L geliefert werden.</p>	
	<p>Caratteristiche La collezione FJORD non è sfoderabile. I tavoli vengono consegnati smontati tranne il tavolo 0S2.</p>	<p>Spec. Characteristics FJORD covers are not removable. The tables are delivered unassembled except for table 0S2.</p>		
				<p>Suppl. de prix Sur demande, la base du fauteuili (code 106) est auss disponible en acier inoxydable 316 L avec un supplement de prix de .</p> <p>Caractéristiques La collection FJORD n'est pas déhoussable. Les tables sont livrées démontées à l'exception de table 0S2.</p>



Fodera Ersatzbez Cover Housse
m Tessuto Stoff Fabric Tissu
m² Pelle Leder Leather Cuir
Kg P. lordo Bruttogew. Gr. Weight Poids Brut
m³ Volume Volumen Volume

Cod. 03K Poltrona Relax opzioni A-C-E

Armchair Relax options A-C-E
Sessel Relax varianten A-C-E
Fauteuil Relax option A-C-E

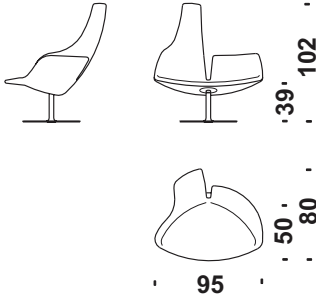

m 3,2 m² 3,3 Kg 34 m³ 0,90

Cod. 001 Poltrona base inox opzioni A-C

Armch. stainless steel base opt.A-C
Sessel Gestell Edelstahl var.A-C
Fauteuil base inox option A-C

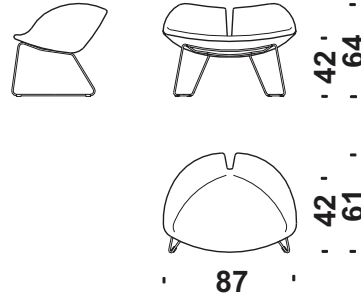

m 2,0 m² 2,8 Kg 14 m³ 0,50

Cod. 0V6 Poltrona girevole opzioni A-C-E

Swivel armchair options A-C-E
Drehsessel varianten A-C-E
Fauteuil pivotant option A-C-E

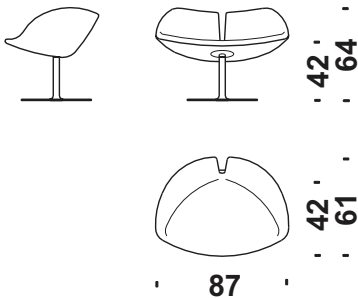

m 2,0 m² 2,8 Kg 28 m³ 0,50

Cod. 214 Fjord pouf piccolo opzioni B-D

Fjord small foot stool options B-D
Fjord Hocker klein varianten B-D
Fjord pouf petit option B-D

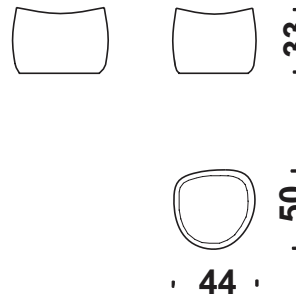

m 0,9 m² 1,7 Kg 10 m³ 0,15

Cod. 017 Fjord pouf opzioni B-D

Fjord foot stool options B-D
Fjord Hocker varianten B-D
Fjord pouf option B-D

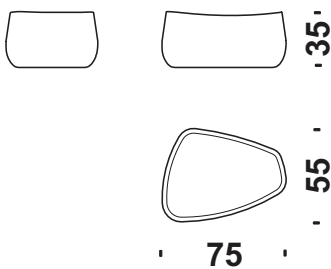

m 1,0 m² 2,1 Kg 14 m³ 0,30

Cod. 077 Fjord pouf grande opzioni B-D

Fjord large foot stool options B-D
Fjord Hocker gross varianten B-D
Fjord pouf grand option B-D

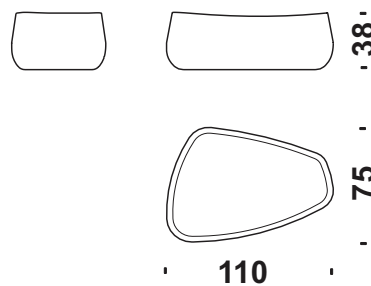

m 1,7 m² 3,4 Kg 21 m³ 0,40



Fodera Ersatzbez Cover Housses
m Tessuto Stoff Fabric Tissu
m² Pelle Leder Leather Cuir
Kg P. lordo Bruttogew. Gr. Weight Poids Brut
m³ Volume Volumen Volume Volumen

Cod. 050 Sedia base cromata opz.C

Chair chromed base opt.C
Stuhl Gestell verchromt var.C
Chaise base chromé opt.C

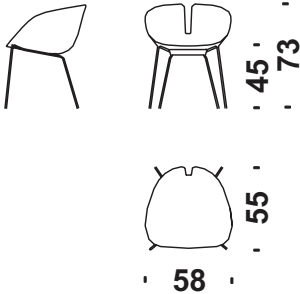

m 1,4 m² 2,2 Kg 10 m³ 0,30

Cod. 105 Poltr.base bianca/grigia opz.C

Armch.white/grey base opt.C
Sessel Gestell weiss/grau var.C
Fauteuil base blanc/gris opt.C

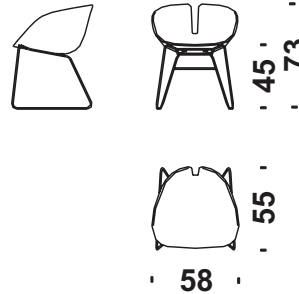

m 1,4 m² 2,2 Kg 10 m³ 0,30

Cod. 106 Poltronc.base inox opz.C

Armch.stainless base opt.C
Sessel Gest.Edelstahl var.C
Fauteuil base inox opt.C

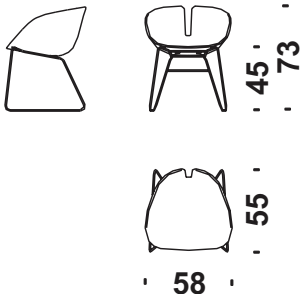

m 1,4 m² 2,2 Kg 10 m³ 0,30

Cod. 0V8 Poltr.girevole base nera opz.C

Swivel small armch.black base opt.C
Drehessel klein Gest.schwarz var.C
Petit faut.pivotant base noir opt.C

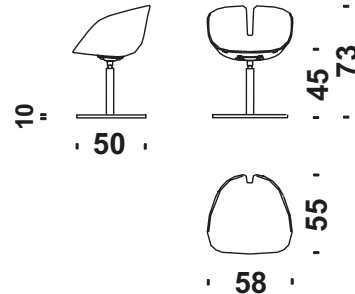

m 1,4 m² 2,2 Kg 15 m³ 0,40

Cod. 108 Poltr.base 5 razze allum.opz.C

Armchair alum.starbase opt.C
Sessel Sterngest.Alum.var.C
Fauteuil base alum.5 br.opt.C

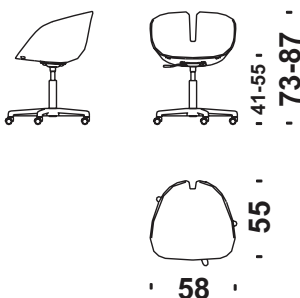

m 1,4 m² 2,2 Kg 13 m³ 0,40

Cod. 111 Sgabello basso base inox opz.C

Bar stool low stainless base opt.C
Barhocker tief Gest.Edelst.var.C
Tab.bar bas base inox opt.C

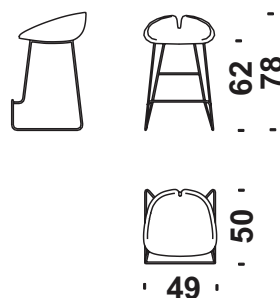

m 1,0 m² 1,2 Kg 10 m³ 0,25



Fodera
Ersatzbez

Cover
Housse

m Tessuto
Stoff

Fabric
Tissu

m² Pelle
Leder

Leather
Cuir

Kg P. lordo
Bruttogew.

Gr. Weight
Poids Brut

m³ Volume
Volumen

Volume
Volume

Cod. 112 Sgabello alto base inox opz.C

Bar stool high stainless base opt.C
Barhocker hoch Gest.Edelst.var.C
Tab.bar haut base inox opt.C

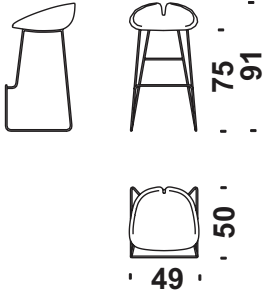

m 1,0 m² 1,2 Kg 10 m³ 0,40

Cod. 07N Sgabello bar girev.vern.all.opz.C

Bar stool swivel varn.al.opt.C
Barhocker drehbar lack.Al.var.C
Tabouret bar piv.vernis al.opt.C

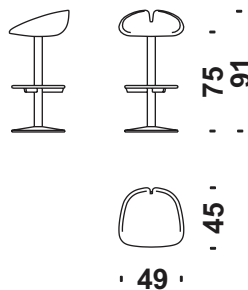

m 1,0 m² 1,2 Kg 30 m³ 0,80

Cod. 114 Sgabello gir.base quadra opz. C-E

Bar stool sw.square base opt. C-E
Barhock.drehbar vier.Gestell var.C-E
Tabouret bar piv.base carré opt.C-E

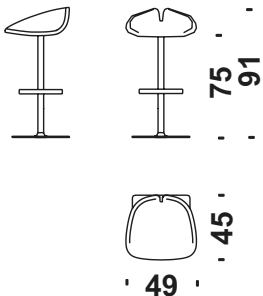

m 1,0 m² 1,2 Kg 30 m³ 0,40

Cod. 116 Barra 4 posti opzioni C

Beam 4 seat options C
Modular System 4-sitz var.C
Poutre 4 places option C

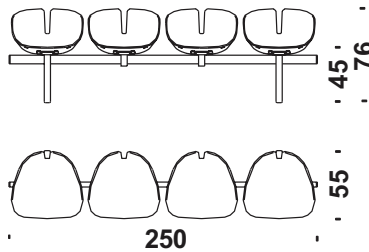

m 5,6 m² 8,8 Kg 44 m³ 1,60

Cod. 117 Barra 5 posti opzioni C

Beam 5 seat options C
Modular System 5-sitz var.C
Poutre 5 places option C

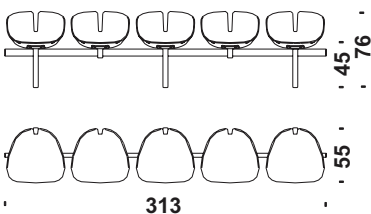

m 7,0 m² 11,0 Kg 55 m³ 1,90

Cod. 119 Barra 4p 1 tavolo opzioni C

Beam 4 seat 1 table options C
Modular System 4-S.1Tisch var.C
Poutre 4 pl.1 table option C

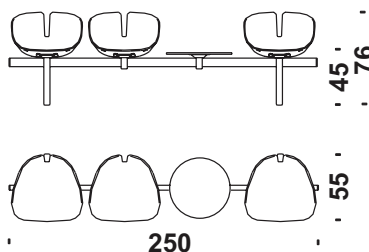

m 4,2 m² 6,6 Kg 36 m³ 1,60



 **Fodera**
Ersatzbez

Cover
Housse

 m **Tessuto**
Stoff

Fabric
Tissu

 m² **Pelle**
Leder

Leather
Cuir

 Kg **P. lordo**
Bruttogew.

Gr. Weight
Poids Brut

 m³ **Volume**
Volumen

Volume
Volume

Cod. 120

Barra 5p 1 tavolo opzioni C

Beam 5 seat 1 table options C
Modular System 5-S.1Tisch var.C
Poutre 5 pl.1 table option C

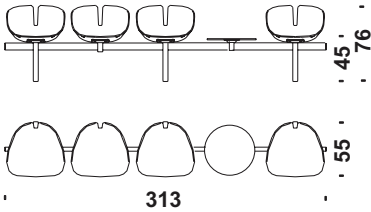

 m 5,6

 m² 8,8

 Kg 47

 m³ 1,90

Cod. 06P

Tavolo quadro

Square table
Viereckiger tisch
Table carré

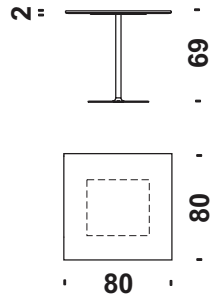

 Kg 25

 m³ 0,50

Cod. 0S2

Tavolo rettangolare

Rectangular table
Rechteckiger Tisch
Table

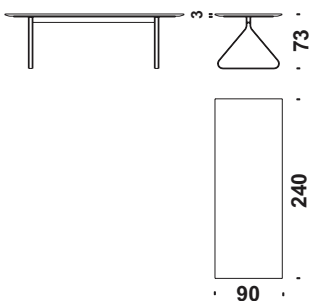

 Kg 200

 m³ 2,80

Cod. 0S1

Tavolo tondo

Round table
Tisch rund
Table rond

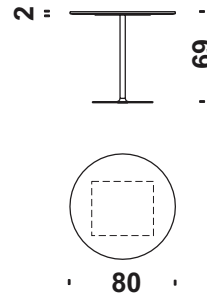

 Kg 25

 m³ 0,50

Cod. 0SA

Tavolo tondo grande

Round table large
Tisch rund gross
Table rond grand

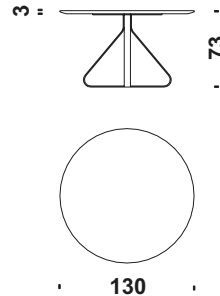

 Kg 125

 m³ 2,00

unica
HOME

www.unicahome.com
1-888-89-UNICA