



Combinazioni modelli & tessuti / Grid of models & fabrics

😊 TIRELLA TESSUTI CONSIGLIATA SUGGESTED FABRIC HANGER

Il numero rosso indica lo specifico tessuto sconsigliato all'interno della tirella.
The number of fabric within the fabric hanger shown in red, is not recommended.

90 Superwhites
92 Polyrock
95 Floribunda I
96 Floribunda II
97 Metropolitan
98 Hip Bazaar
100 Cross Over 1
101 Cross Over 2
103 My Tip
104 Net - Work
105 Chelsea - Girl
Divina - Divina Melange
Tonus
Pelle T / Leather T

😞 TIRELLA TESSUTI SCONSIGLIATA NOT RECOMMENDED FABRIC HANGER

Il numero verde indica lo specifico tessuto consigliato all'interno della tirella.
The green numbers show the suggested specific fabrics within the fabric hanger.

73 Grainderiz
81 Uniforms
87 Washables
91 FIT 2
93 Remix 1/3
99 Structures **bergen wave**
102 The Specials
Stamskin Top - Extrema

😊 TIRELLE SENZA INDICAZIONI SPECIFICHE NO SPECIFIC INSTRUCTIONS

E' necessario prestare attenzione alle indicazioni tecniche e sartoriali riportate sulle stesse.
Please refer to labels shown on the fabric samples.

71 Mohair & Velluti / Velvets
94 Timeless
4,8 only cushion
Hallingdal
Alcantara
Pelle Z / Leather Z

Per qualsiasi richiesta particolare non prevista, si prega di contattare il Ns Ufficio commerciale.
For specific questions or requests, please contact your sales rep. or our sales office in Italy.

Materiale e finiture / Materials and Finishings / Materialien und Ausführungen / Matériaux et Finitions

Colori tavoli Springfield 2008 / Springfield 2008 Tables colors / Farben Tische Springfield 2008 / Couleurs Tables Springfield 2008



Ral 9003
Bianco lucido
White polished
Weiss hochglanz
Blanc brillant



Ral 9005
Nero lucido
Black polished
Schwarz hochglanz
Noir brillant



Ral 3020
Rosso lucido
Red polished
Rot hochglanz
Rouge brillant



Ral 7047
Grigio lucido
Grey polished
Grau hochglanz
Gris brillant

Le finiture qui riprodotte sono indicative. Leggeri scostamenti non verranno accettati come reclamo.
Finishings may slightly change. Light differences will not be accepted as complaint.
Farbabweichungen gegenüber den Mustern sind möglich und müssen akzeptiert werden.
Les couleurs reprises sur cette page sont indicatives et de légères différences ne seront pas acceptées comme non-conformités.



www.unicahome.com
1-888-89-UNICA

Attenzione Per ordini di composizioni, allegare un'accurata descrizione integrata con un disegno. Nelle comp. realizzabili con gli elementi riportati, considerare una luce di 3,5 cm. tra gli elementi stessi. Le dimensioni d'ingombro riportate sui disegni, si intendono non comprensive dei dispositivi di collegamento. Nel caso di ordini di elementi per comp. a sé stanti o con tavolo inserito, si prega di specificarlo all'atto dell'ordinazione per permettere una corretta produzione della fodera.

Attention When ordering compositions, please include an accurate description and plan of configuration. When creating compositions, please note that the linking device adds 3,5 cm / 1 3/8" to width of single elements. If one element is to be used alone or with a table, please indicate it on your order to allow us to produce the cover correctly.

Achtung Fuer Auftraegen fuer Sitzlandsch. bitte eine genaue Beschreibung beilegen, mit Zeichnung. Bei Zusammen. von Einzel. bitte beruecksicht., dass die Verbindungstuecke 3,5 cm. lang sind. Die Zeichnungen in der Preisliste sind ohne dieses Mass. Dieser Abstand muss dann auch fuer die Gesamtbreite der Zusammen. beruecksichtigt werden. Bitte mitteilen ob Einzel. freistehend oder in Verbindung mit Tische bestellt werden damit die Bezeuge korrekt gefertigt werden.

Attention Pour les commandes de comp., envoyez une description précise et un dessin. Pour les comp. réalisées avec des éléments composables, considérez un espace de 3,5 cm. entre les éléments. Les dimensions reportées sur les dessins ne tiennent pas compte de ces espaces entre les éléments. Dans le cas où les éléments d'une comp. sont utilisés seuls ou avec une table, veuillez nous en aviser dans votre commande pour nous permettre une finition correcte de la housse.

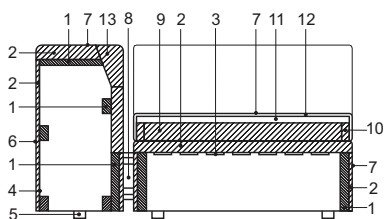

Legenda - Description

- 1 Struttura in legno
Hardwood frame
Holzstruktur
Structure en bois
- 2 9 - 10 - 13: Poliuretani a densità e portanza differenziate
9 - 10 - 13: Polyurethane foam in varied densities
9 - 10 - 13: Polyurethanschaum in untersch. Raumdichtigkeiten
9 - 10 - 13: Mousse polyuréth. à densités différenciées
- 3 Cinghie elastiche da 60 mm.
Elastic belts 60 mm.
Elastische Gurte 60 mm.
Sangles élastiques de 60 mm.
- 4 Legno con spessore 2,5 mm.
Wood 2,5 mm thick
Holz Stärke 2,5 mm.
Bois de 2,5 mm. d'épaisseur
- 5 Piedi in polipropilene
Polypropylene feet
Polypropylenfüss
Pieds en polypropylène
- 6 Ovatta poliesteri da 100 gr/mq.
Polyester fiberfill 100 gr/mq.
Polyesterwatte 100 gr/mq.
Fibre Polyestère à 100 gr/mq.
- 7 Rivestimento in tela di cotone 100%
100% cotton cover
Überzug aus Baumwolle 100%
Revêtement coton 100%
- 8 Dispositivo di colleg. in acciaio
Steel joining device
Verbindungseinheit in Stahl
Dispositif d'union en acier
- 11 Settori con piumino d'oca
Goose down insert
Einlagen mit Gans Daune
Sections à duvet d'oie
- 12 Tela cotone 100% accoppiata ad ovatta poliesteri da 100 gr/mq.
100% cotton fabric with polyester fiberfill 100 gr/mq.
Baumwollstoff verbunden mit Polyesterwatte 100 gr/mq.
Mélange de coton 100% et de fibre polyestère à 100 gr/mq.

Struttura

Fusto in legno rivestito con poliuretano espanso indeformabile a densità differenziate e fibra poliesteri. Piedi in polipropilene. La poltroncina (cod. 061) ha i piedi in alluminio spazzolato. Il colore del copri dispositivo di collegamento è NERO. TAVOLI: Piano in alluminio alveolare verniciato bianco RAL 9003, nero RAL 9005, rosso RAL 3020 e grigio RAL 7047.

Imbottitura cuscini

I cuscini del sedile sono in piumino d'oca con supporto in poliuretano espanso a densità differenziate e fibra poliesteri. I cuscini dello schienale sono in piuma d'oca.

Sovrapprezzi

I prezzi indicati a listino sono del solo elemento. Il prezzo totale dell'articolo si ottiene aggiungendo al prezzo dell'elemento quello dei cuscini di schiena nelle quantità desiderate dal cliente. I cuscini tratteggiati indicano le quantità suggerite dall'azienda.

Caratteristiche

La collezione SPRINGFIELD 2008 è sfoderabile e SMONTABILE ad eccezione dei codici: 001-011-04R-072-073-012-013.

NON SI ACCETTANO ORDINI DI ELEMENTI FUORI MISURA.

Structure

Stress-resistant polyurethane foam in varied densities and polyester fiberfill on hardwood frame. Polypropylene feet. Small armchair (cod. 061) has aluminum feet. Joining device cover is BLACK. TABLES: Lacquered top is honeycomb aluminum. Available colors: white RAL 9003, black RAL 9005, red RAL 3020 or grey RAL 7047.

Padding

Seat cushions are goose down over polyurethane foam in varied densities and polyester fiberfill. Back cushion are goose down.

Surcharge

Sofa prices do not include loose back cushions; add prices of loose back cushions for total price. Loose back cushions as shown in the drawings are only a suggestion of how many may be used.

Spec. Characteristics

SPRINGFIELD 2008 fabric covers are completely removable. Elements are delivered unassembled, except for codes: 001-011-04R-072-073-012-013.

REQUESTS FOR SPECIAL SIZES CANNOT BE ACCEPTED.

Struktur

Aus Holz, mit unverformbarem Polyurethanschaum in unterschiedlichen Raumdichtigkeiten und Polyesterwatte. Füße: polypropilen. Die Füsse der Sessel klein (Kod. 061) sind aus Aluminium. Die Farbe für die Verbindungselemente ist SCHWARZ. TISCHEN: Lackierte Tischplatte aus "Honeycomb" Aluminium. Farben: weiss RAL 9003, schwarz RAL 9005, rot RAL 3020 und grau RAL 7047.

Kissen Füllung

Die Sitzkissen sind aus Gaensedaune mit Polyurethanschaum kern in unterschiedlicher Raumdichtigkeit und Polyesterwatte. Die Rückenkissen ausschliesslich in Daune.

Aufpreis

Angegebene Preise beziehen sich ausschliesslich auf die Polsterelemente. Lose Kissen sind im Preis nicht einbegriffen. Bitte Preis der losen Kissen dazurechnen um den Totalpreis zu erhalten.

Besonderheiten

Kollektion SPRINGFIELD 2008 ist Komplett abziehbar und sind MONTIERBAR, ausgenommen der Kodens: 001-011-04R-072-073-012-013.

SONDERANFERTIGUNGE N KOENNEN NICHT ANGENOMMEN WERDEN.

Structure

En bois recouverte de mousse polyuréthane indéformable à densités différenciées et ouatte syntétique. Pieds en polypropylène. La petit fauteuil (cod. 061) a les pieds en aluminium. Le couleur du dispositif d'union est NOIR. TABLES: Plateau en aluminium "Honeycomb" verni blanc RAL 9003, noir RAL 9005, rouge RAL 3020 et gris RAL 7047.

Rembourrage

Les coussins de l'assise sont en duvet d'oie avec support en polyuréthane expansé à densités différenciées et ouatte synthétique. Les coussins du dossier sont en duvet.

Suppl. de prix

Les prix indiqués se réfèrent seulement à l'élément. Le prix final s'obtient en y ajoutant le prix des coussins du dossier. Le client peut commander la quantité désirée. Le nombre de coussins dossier indiqué en pointilles est indicatif et seulement conseille par Moroso.

Caractéristiques

La collection SPRINGFIELD 2008 est complètement déhoussable et est DEMONTABLE à l'exception des codes: 001-011-04R-072-073-012-013.

COMMANDES HORS MESURE NE SONT PAS ACCEPTÉES.



 **Fodera**
Ersatzbez

Cover
Housse

 m **Tessuto**
Stoff

Fabric
Tissu

 m² **Pelle**
Leder

Leather
Cuir

 Kg **P. lordo**
Bruttogew.

Gr. Weight
Poids Brut

 m³ **Volume**
Volumen

Volume
Volume

Cod. 002

Divano 2 posti

2 seater sofa
Sofa 2-Sitzig
Canapé 2 places

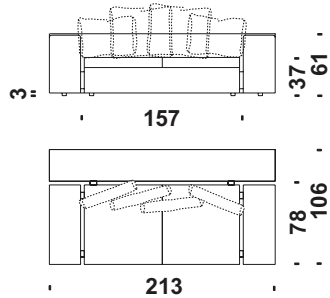

 m 10,3  m² 19,0  Kg 106  m³ 1,40

Cod. 018

Divano 2 posti major

2 seater sofa major
Sofa 2-Sitzig major
Canapé 2 places major

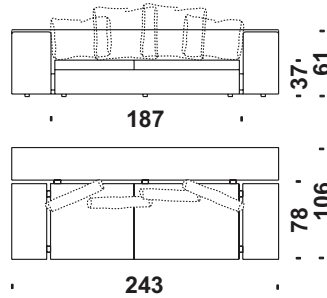

 m 11,3  m² 21,0  Kg 113  m³ 1,60

Cod. 003

Divano 3 posti

3 seater sofa
Sofa 3-Sitzig
Canapé 3 places

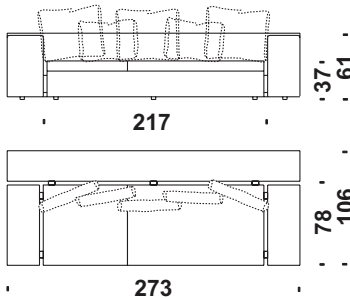

 m 12,0  m² 22,8  Kg 122  m³ 2,50

Cod. FL0EU

Field cuscino schiena 60x54x7

Field back cushion 60x54x7
Field Ruecken Kissen 60x54x7
Field coussin dos 60x54x7

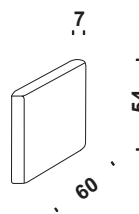

 m 1,0  m² 1,3

Cod. FL0EX **Field cuscino sch.con rullo 60x54x7**

Field back cush.with roll 60x54x7
Field Ruecken Kiss.mit rolle 60x54x7
Field couss.dos avec rouleau 60x54x7

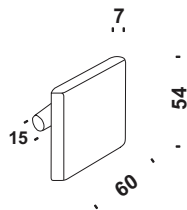

 m 1,7  m² 2,1

Cod. FL0KL **Field cuscino schiena 56x43x9**

Field back cushion 56x43x9
Field Ruecken Kissen 56x43x9
Field coussin dos 56x43x9

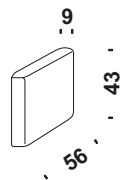

 m 1,2  m² 1,5

unica
HOME

www.unicahome.com
1-888-89-UNICA

Fodera
Ersatzbez

Cover
Housse

m Tessuto
Stoff

Fabric
Tissu

m² Pelle
Leder

Leather
Cuir

Kg P. lordo
Bruttogew.

Gr. Weight
Poids Brut

m³ Volume
Volumen

Volume
Volume

Cod. 001

Poltrona 75

Armchair 75
Sessel 75
Fauteuil 75

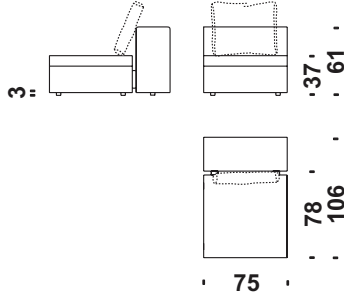

m 4,0 m² 8,3 Kg 45 m³ 0,60

Cod. 01G

Poltrona con braccioli

Armchair with arms
Sessel mit Armlehnen
Fauteuil avec accoudoirs

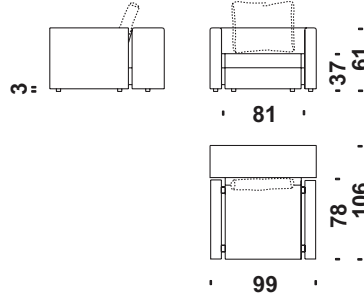

m 6,6 m² 12,6 Kg 52 m³ 1,00

Cod. 011

Elemento centrale 75

Central element 75
Zentralelement 75
Elément central 75

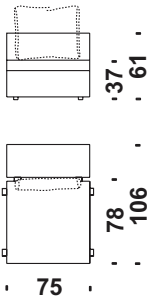

m 4,0 m² 8,4 Kg 45 m³ 0,60

Cod. 04R

Elemento centrale 105

Central element 105
Zentralelement 105
Elément central 105

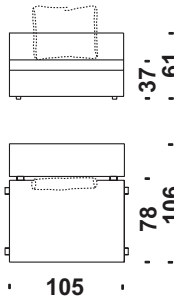

m 4,8 m² 9,1 Kg 49 m³ 0,70

Cod. 04T

Elemento centrale 180

Central element 180
Zentralelement 180
Elément central 180

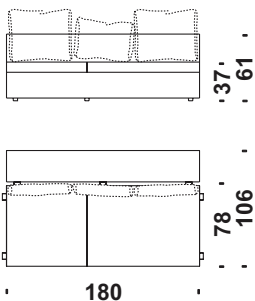

m 7,3 m² 14,4 Kg 78 m³ 1,20

Cod. 04S

Chaise Longue centrale

Chaise Longue central
Chaise Longue Zentral
Chaise Longue central

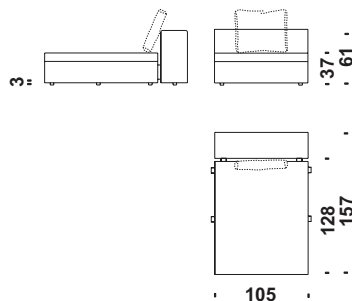

m 5,4 m² 11,2 Kg 57 m³ 1,20

unica
HOME

www.unicahome.com
1-888-89-UNICA

Fodera
Ersatzbez

Cover
Housse

m Tessuto
Stoff

Fabric
Tissu

m² Pelle
Leder

Leather
Cuir

Kg P. lordo
Bruttogew.

Gr. Weight
Poids Brut

m³ Volume
Volumen

Volume
Volumen

Cod. 073

Angolo sinistro

Corner left
Ecke links
Angle gauche

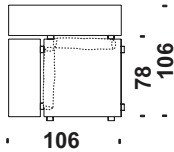
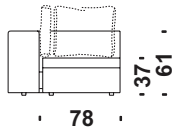

m 5,3

m² 10,1

Kg 54

m³ 0,70

Cod. 072

Angolo destro

Corner right
Ecke rechts
Angle droit

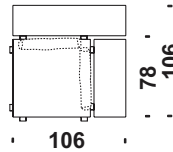
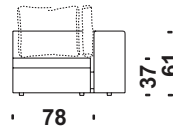

m 5,3

m² 10,1

Kg 54

m³ 0,70

Cod. 013

Elemento 1p sinistro

Lateral 1 seat unit left
Seiten Element links
Elément latérale gauche

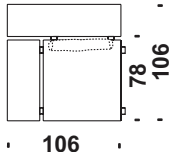
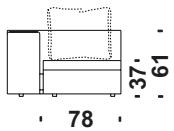

m 5,7

m² 10,9

Kg 55

m³ 0,70

Cod. 012

Elemento 1p destro

Lateral 1 seat unit right
Seiten Element rechts
Elément latérale droit

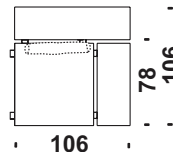
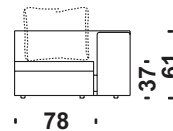

m 5,7

m² 10,9

Kg 55

m³ 0,70

Cod. 023

Elemento 2p sinistro

Lateral 2 seat unit left
2 Sitz-Element links
Elément latérale gauche

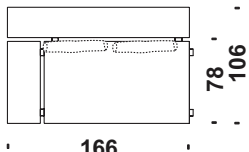
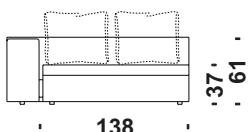

m 7,7

m² 14,2

Kg 78

m³ 1,20

Cod. 022

Elemento 2p destro

Lateral 2 seat unit right
2 Sitz-Element rechts
Elément latérale droit

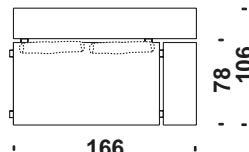
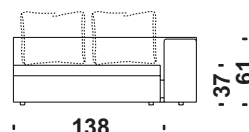

m 7,7

m² 14,2

Kg 78

m³ 1,20

unica
HOME

www.unicahome.com

1-888-89-UNICA

Fodera
Ersatzbez

Cover
Housse

m Tessuto
Stoff

Fabric
Tissu

m² Pelle
Leder

Leather
Cuir

Kg P. lordo
Bruttogew.

Gr. Weight
Poids Brut

m³ Volume
Volumen

Volume
Volume

Cod. 037

Elemento 2p major sinistro

Lateral 2 seat unit major left
2-Sitz Element major links
Elément latérale major gauche

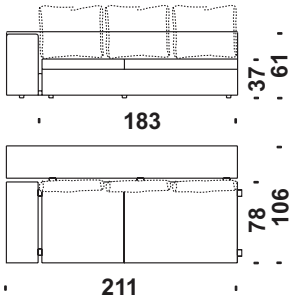

m 9,7 m² 17,6 Kg 96 m³ 1,60

Cod. 031

Elemento 2p major destro

Lateral 2 seat unit major right
2-Sitz Element major rechts
Elément latérale major droit

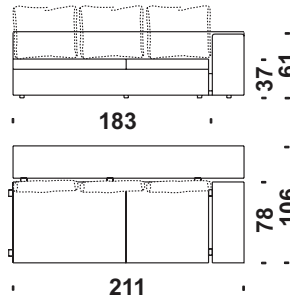

m 9,7 m² 17,6 Kg 96 m³ 1,60

Cod. 033

Elemento 3p sinistro

Lateral 3 seat unit left
3-Sitz Element links
Elément latérale gauche

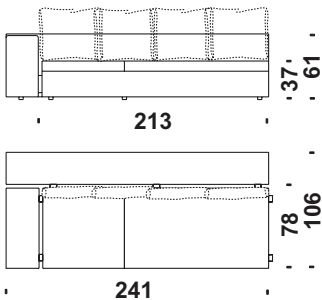

m 10,7 m² 19,7 Kg 103 m³ 1,80

Cod. 032

Elemento 3p destro

Lateral 3 seat unit right
3-Sitz Element rechts
Elément latérale droit

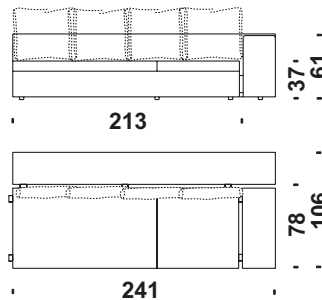

m 10,7 m² 19,7 Kg 103 m³ 1,80

Cod. 06W

Chaise Longue term.sx

Chaise Longue side left
Chaise Longue Seitl.links
Chaise Longue à coté gauche

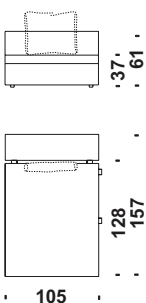

m 5,4 m² 11,2 Kg 57 m³ 1,20

Cod. 06V

Chaise Longue term.dx

Chaise Longue side right
Chaise Longue Seitl.rechts
Chaise Longue à coté droit

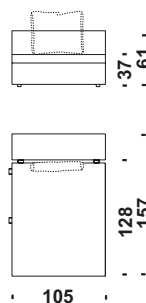

m 5,4 m² 11,2 Kg 57 m³ 1,20



Fodera
Ersatzbez
Cover
Housse

m Tessuto
Stoff

Fabric
Tissu

m² Pelle
Leder

Leather
Cuir

Kg P. lordo
Bruttogew.

Gr. Weight
Poids Brut

m³ Volume
Volumen
Volume

Cod. 0D4

Chaise Longue bracc.sx

Chaise Longue arm left
Chaise Longue Armlehne links
Chaise Longue accoudoir gauche

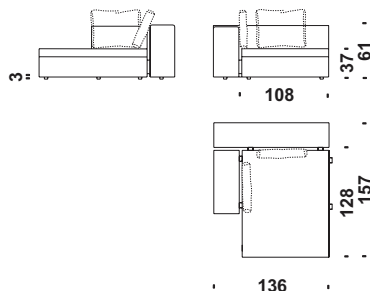

m 7,3 m² 15,3 Kg 79 m³ 1,40

Cod. 0D3

Chaise Longue bracc.dx

Chaise Longue arm right
Chaise Longue Armlehne rechts
Chaise Longue accoudoir droit

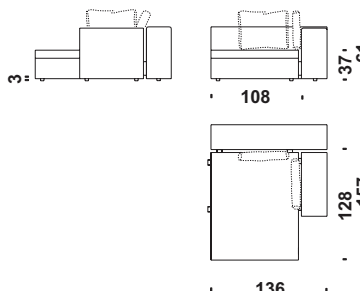

m 7,3 m² 15,3 Kg 79 m³ 1,40

Cod. 061

Poltroncina

Small armchair
Sessel Klein
Petit fauteuil

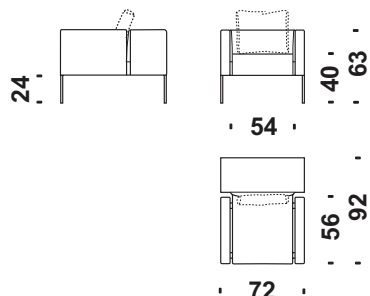

m 3,3 m² 5,6 Kg 28 m³ 0,60

Cod. 0G1

Pouf centrale 75x106

Central stool 75x106
Zentral Hocker 75x106
Pouf central 75x106

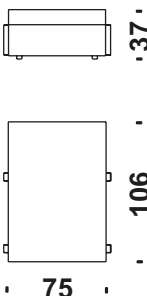

m 3,1 m² 6,5 Kg 34 m³ 0,40

Cod. 0G4

Pouf Lounge 106x75

Stool Lounge 106x75
Hocker Lounge 106x75
Pouf Lounge 106x75

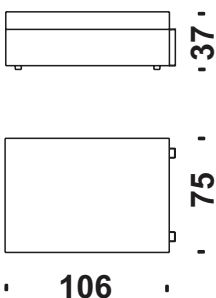

m 3,1 m² 6,5 Kg 34 m³ 0,40

Cod. 0G2

Pouf terminale sx 75x106

Terminal stool left 75x106
Abschlussocker links 75x106
Pouf terminal gauche 75x106



m 3,1 m² 6,4 Kg 34 m³ 0,40



Fodera
Ersatzbez

Cover
Housse

m Tessuto
Stoff

Fabric
Tissu

m² Pelle
Leder

Leather
Cuir

Kg P. lordo
Bruttogew.

Gr. Weight
Poids Brut

m³ Volume
Volumen

Volume
Volume

Cod. 0G3

Pouf terminale dx 75x106

Terminal stool right 75x106
Abschlusshocker rechts 75x106
Pouf terminal droit 75x106

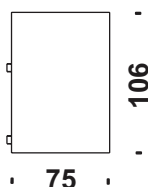
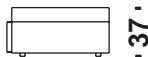

m 3,1 m² 6,5 Kg 34 m³ 0,40

Cod. 0G5

Pouf centrale 106x106

Central stool 106x106
Zentral Hocker 106x106
Pouf central 106x106

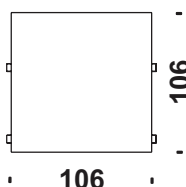
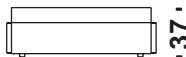

m 4,2 m² 8,1 Kg 40 m³ 0,50

Cod. 0G8

Pouf ad angolo 106x106

Corner stool 106x106
Eckenhocker 106x106
Pouf angle 106x106

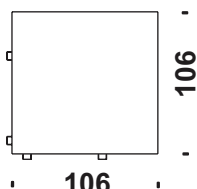

m 4,2 m² 8,1 Kg 40 m³ 0,50

Cod. 0G6

Pouf terminale sx 106x106

Terminal stool left 106x106
Abschlusshocker links 106x106
Pouf terminal gauche 106x106

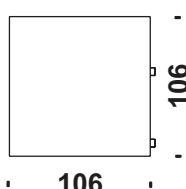
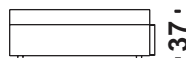

m 4,2 m² 8,1 Kg 40 m³ 0,50

Cod. 0G7

Pouf terminale dx 106x106

Terminal stool right 106x106
Abschlusshocker rechts 106x106
Pouf terminal droit 106x106

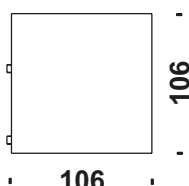
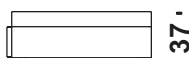

m 4,2 m² 8,1 Kg 40 m³ 0,50

Cod. 017

Springfield 2008 pouf 75x106

Springfield 2008 stool 75x106
Springfield 2008 Hocker 75x106
Springfield 2008 pouf 75x106

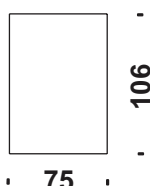
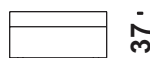

m 3,1 m² 6,4 Kg 34 m³ 0,40



Fodera
Ersatzbez

Cover
Housse

m Tessuto
Stoff

Fabric
Tissu

m² Pelle
Leder

Leather
Cuir

Kg P. lordo
Bruttogew.

Gr. Weight
Poids Brut

m³ Volume
Volumen

Volume
Volume

Cod. 077

Springfield 2008 pouf 106X106

Springfield 2008 stool 106X106
Springfield 2008 Hocker 106X106
Springfield 2008 pouf 106X106

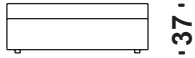

106

m 4,2

m² 8,1

Kg 40

m³ 0,50

Cod. SL0CC

Tavolo 98x98x28

Table 98x98x28
Tisch 98x98x28
Table 98x98x28



98

Kg 15

m³ 0,35

Cod. SL0CG

Tavolo 98x49x28

Table 98x49x28
Tisch 98x49x28
Table 98x49x28

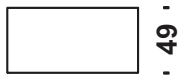

98

Kg 8

m³ 0,30

Cod. SL0CH

Tavolo 147x49x28

Table 147x49x28
Tisch 147x49x28
Table 147x49x28

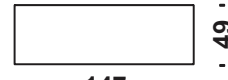
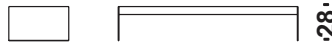

147

Kg 11

m³ 0,30



www.unicahome.com

1-888-89-UNICA