

Attenzione NEL RIVESTIMENTO BICOLORE CUCITURE IN ABBINAMENTO SEDUTA ANTERIORE A VISTA.

Attention FOR TWO COLORS COVER SEWINGS COUPLING WITH FRONT SEAT FABRIC.

Achtung BEZUG ZWEIFARBIG, NAHTE ZUORDNUNG SITZFLAECHE.

Attention HOUSSE BICOLORE, COUTURES ASSORTIES AVEC TISSU ASSISE ANTERIEURE.

Legenda - Description	Struttura	Structure	Struktur	Structure
<p>1 Struttura in acciaio Steel structure Stahlstruktur Structure en acier</p> <p>2 Schiuma poliuretana flessibile con densità 60 Kg/mc. Flexible polyurethane foam density 60 Kg/mc. Flexibler Polyurethanschaum, Dichtigkeit 60 Kg/mc. Mousse en polyuréthane flexible à densité 60 kg/mc.</p> <p>3 Ovatta poliestere da 100 gr/mq. Wadding 100 gr/mq. Watte 100 gr/mq. Fibre polyester a 100 gr/mq.</p> <p>4 Rivestimento in tela di cotone 100% Cover in pure-cotton fabric Überzug aus Baumwolle 100% Revêtement coton 100%</p> <p>5 Piede in acciaio verniciato Feet in varnished steel Fuesse aus lackiertem Stahl Pied en acier verni</p>	<p>Espanso schiumato a freddo con struttura interna in acciaio. Piedi in acciaio verniciato M3073.</p> <p>TAVOLI: Acciaio verniciato M3073. Piano con spessore mm. 30 in poliuretano rigido laccato lucido e tinto bianco, rosso, nero e beige. Piedi in inox. Sottopiede in polietilene</p> <p>Imbottitura cuscini I cuscini dello schienale sono in piuma d'oca</p> <p>Caratteristiche La collezione MALMÖ è sfoderabile. In pelle è fissa. I tavoli vengono consegnati smontati. Sono disponibili a richiesta le seguenti versioni con i relativi codici: a) versione con pelle nella parte anteriore e tessuto nella parte posteriore: div.2p = 0VA; div.2p major = 0VB; div.3p = 0VC; Chaise Longue = VD; poltrona = 0VE. b) versione con 2 tessuti diversi: div.2p = 0VF; div.2p major = 0VG; div.3p = 0VH; Chaise Longue = VL; poltrona = 0VM. N.B.. In tutti questi codici sono SEMPRE compresi i cuscini di schiena prodotti anch'essi nei 2 rivestimenti.</p> <p>NON SI ACCETTANO ORDINI DI ELEMENTI FUORI MISURA.</p>	<p>Steel frame covered with injected polyurethane foam. Feet in varnished steel M3073.</p> <p>TABLES: Varnished steel M3073. Top, thickness mm. 30, in rigid polyurethane, glossy lacquered colour white, red, black and beige. Feet in stainless steel. Underfeet in polyethylene.</p> <p>Padding Back cushions are in goose dawn.</p> <p>Spec. Characteristics The collection MALMÖ has removable covers. Leather execution is fix. The tables are delivered knocked down (K.D.) On request, following versions are available with their own codes: a) version covered with leather on the front side and fabric on the back side: 2 seat sofa = 0VA; 2 seat sofa major = 0VB; 3 seat sofa = 0VC; Chaise Longue = VD; armchair = 0VE. b) version covered with two different fabrics: 2 seat sofa = 0VF; 2 seat sofa major = 0VG; 3 seat sofa = 0VH; Chaise Longue = VL; armchair = 0VM. All these versions ALREADY include the back cushions which are also covered with two different materials.</p> <p>REQUESTS FOR CUSTOM VERSIONS CANNOT BE ACCEPTED</p>	<p>Das Modell bestehen aus einem Stahlgestell in kaltgeschäumtem Schaumstoff. Fuesse aus lackiertem Stahl M3073.</p> <p>TISCHE: Stahl lackiert M3073. Tischplatte, Dicke 30 mm., in festem Polyurethan Lackiert farbe weiss, rot, schwarz und beige. Füsse aus Edelstahl. Unterfüsse in Polyethylen.</p> <p>Kissen Füllung Rückenkissen in Daune.</p> <p>Besonderheiten Kollektion MALMÖ ist abziehbar. Leder Ausführung ist fix. Die Tische werden abmontiert geliefert. Auf Anfrage sind folgende Ausführungen (siehe entsprechende Kodernr.) verfügbar: a) Überzug vorne Leder, hinten Stoff: sofa 2 stz. = 0VA; sofa 2 stz.major = 0VB; sofa 3 stz. = 0VC; Chaise Longue = VD; sessel = 0VE. b) Überzug mit zwei unterschiedlichen Stoffe: sofa 2 stz. = 0VF; sofa 2 stz.major = 0VG; sofa 3 stz. = 0VH; Chaise Longue = VL; sessel = 0VM. Diese Kodenummern sind einschliesslich Rückenkissen in der gleichen Stoff- bzw. Ledervariante.</p> <p>SONDERANFERTIGUNGE N KOENNEN NICHT AUSGEFUEHRT WERDEN.</p>	<p>En acier enrobée dans la mousse injectée a froid. Pieds en acier verni M3073.</p> <p>TABLES: En acier verni M3073. Plan, épaisseur 30 mm., en polyuréthane rigide, lacqué brillant couleur blanc, rouge, noir et beige. Pieds en acier inoxydable. Sous-pieds en polyethylene.</p> <p>Rembourrage Les coussins du dossier sont en duvet.</p> <p>Caractéristiques La collection MALMÖ est déhoussable. En cuir fixe. Les tables sont livrées démontées. Sur demande, les versions suivantes sont disponibles avec des codes différents: a) version recouverte en cuir sur la partie frontale et en tissu sur la partie postérieure: canapé 2 pl. = 0VA; canapé 2 pl. major = 0VB; canapé 3 pl. = 0VC; Chaise Longue = VD; fauteuil = 0VE. b) version recouverte avec deux tissus différents: canapé 2 pl. = 0VF; canapé 2 pl. major = 0VG; canapé 3 pl. = 0VH; Chaise Longue = VL; fauteuil = 0VM. N.B. Ces versions comprennent déjà les coussins du dossier qui seront eux aussi recouverts avec les deux matériaux.</p> <p>COMMANDES HORS MESURE NE SONT PAS ACCEPTEES.</p>

Fodera
Ersatzbez
Cover
Housse

m Tessuto
Stoff

Fabric
Tissu

m² Pelle
Leder

Leather
Cuir

Kg P. lordo
Bruttogew.

Gr. Weight
Poids Brut

m³ Volume
Volumen

Volume
Volume

Cod. 002

Divano 2 posti

2 seater sofa
Sofa 2-Sitzig
Canapé 2 places

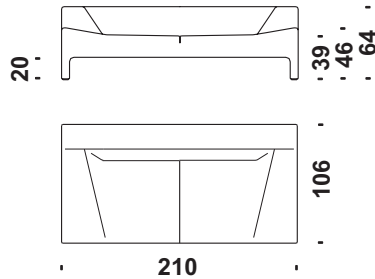

m 7,7 m² 15,5 Kg 91 m³ 1,6

Cod. 018

Divano 2 posti major

2 seater sofa major
Sofa 2-Sitzig Major
Canapé 2 places major

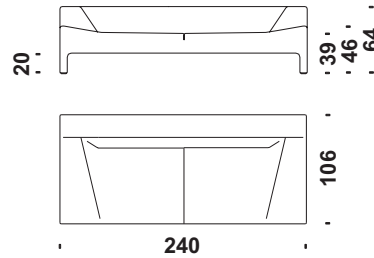

m 8,7 m² 17,5 Kg 96 m³ 1,9

Cod. 003

Divano 3 posti

3 seater sofa
Sofa 3-Sitzig
Canapé 3 places

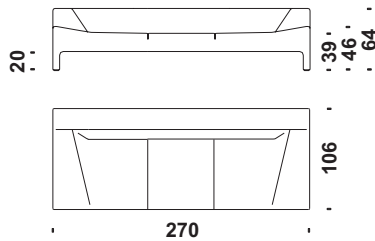

m 9,7 m² 19,5 Kg 103 m³ 2,1

Cod. 0V0

Divano 2p con cuscini

2 seater sofa with cushions
Sofa 2-Sitzig mit Kissen
Canapé 2 places avec coussins

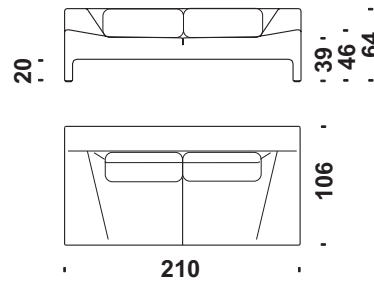

m 9,7 m² 18,5 Kg 96 m³ 1,6

Cod. 0V4

Divano 2p major con cusc.

2 seater sofa major with cushions
Sofa 2-Sitzig major mit Kissen
Canapé 2 places major avec couss.

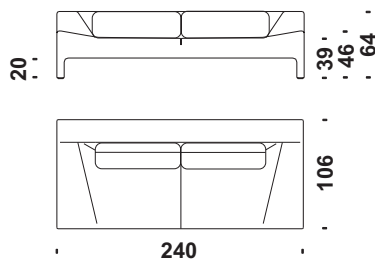

m 11,2 m² 21 Kg 101 m³ 1,9

Cod. 0V5

Divano 3p con cuscini

3 seater sofa with cushions
Sofa 3-Sitzig mit Kissen
Canapé 3 places avec coussins

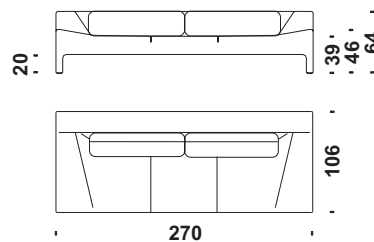

m 12,6 m² 23,6 Kg 108 m³ 2,1

Fodera
Ersatzbez

Cover
Housse

Tessuto
Stoff

Fabric
Tissu

Pelle
Leder

Leather
Cuir

Kg
P. lordo
Bruttogew.

Gr. Weight
Poids Brut

m³
Volume
Volumen

Volume
Volume

Cod. 001

Poltrona

Armchair
Sessel
Fauteuil

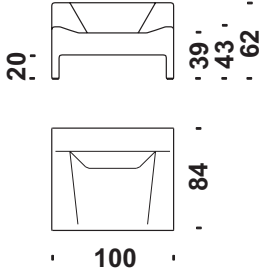

m 4

m² 7

Kg 43

m³ 0,7

Cod. 036

Chaise Longue

Chaise Longue
Chaise Longue
Chaise Longue

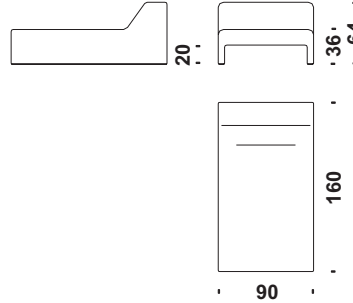

m 5,1

m² 8,6

Kg 54

m³ 1

Cod. 017

Malmö pouf

Malmö stool
Malmö Hocker
Malmö pouf

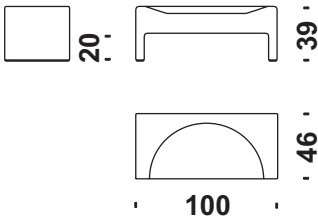

m 2,1

m² 3,8

Kg 17

m³ 0,3

Cod. 0KU

Malmö cuscino 63x34

Malmö cushion 63x34
Malmö Kissen 63x34
Malmö coussin 63x34

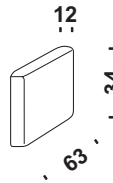

m 1,1

m² 1,4

Cod. 0KV

Malmö cuscino 78x34

Malmö cushion 78x34
Malmö Kissen 78x34
Malmö coussin 78x34

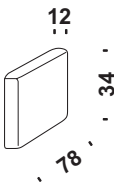

m 1,3

m² 1,7

Cod. 0KY

Malmö cuscino 93x34

Malmö cushion 93x34
Malmö Kissen 93x34
Malmö coussin 93x34

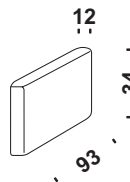

m 1,5

m² 2,1

 **Fodera**
Ersatzbez

Cover
Housse



Tessuto
Stoff

Fabric
Tissu



Pelle
Leder

Leather
Cuir



P. lordo
Bruttogew.

Gr. Weight
Poids Brut



Volume
Volumen

Volume
Volume

Cod. 0CK

Tavolo 80x65x28

Table 80x65x28
Tisch 80x65x28
Table 80x65x28

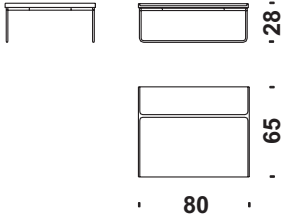

 Kg 13

 m³ 0,10

Cod. 0CL

Tavolo 80x130x28 tipo A

Table 80x130x28 type A
Tisch 80x130x28 tjp A
Table 80x130x28 tje A

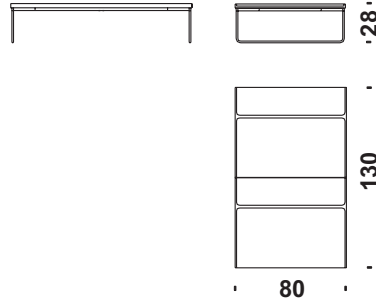

 Kg 15

 m³ 0,17

Cod. 0CQ

Tavolo 80x130x28 tipo B

Table 80x130x28 type B
Tisch 80x130x28 tjp B
Table 80x130x28 tje B

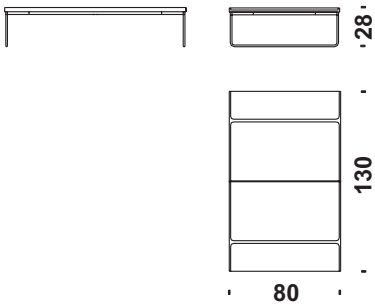

 Kg 15

 m³ 0,17

Cod. 0CT

Tavolo 80x130x28 tipo C

Table 80x130x28 type C
Tisch 80x130x28 tjp C
Table 80x130x28 tje C

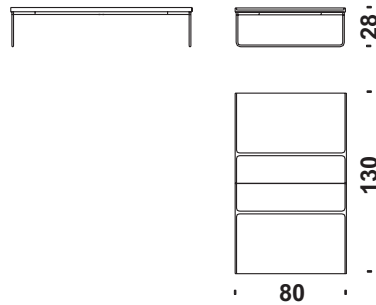

 Kg 15

 m³ 0,17