

Rowenta



JASPER MORRISON



www.unicahome.com
1-888-89-UNICA

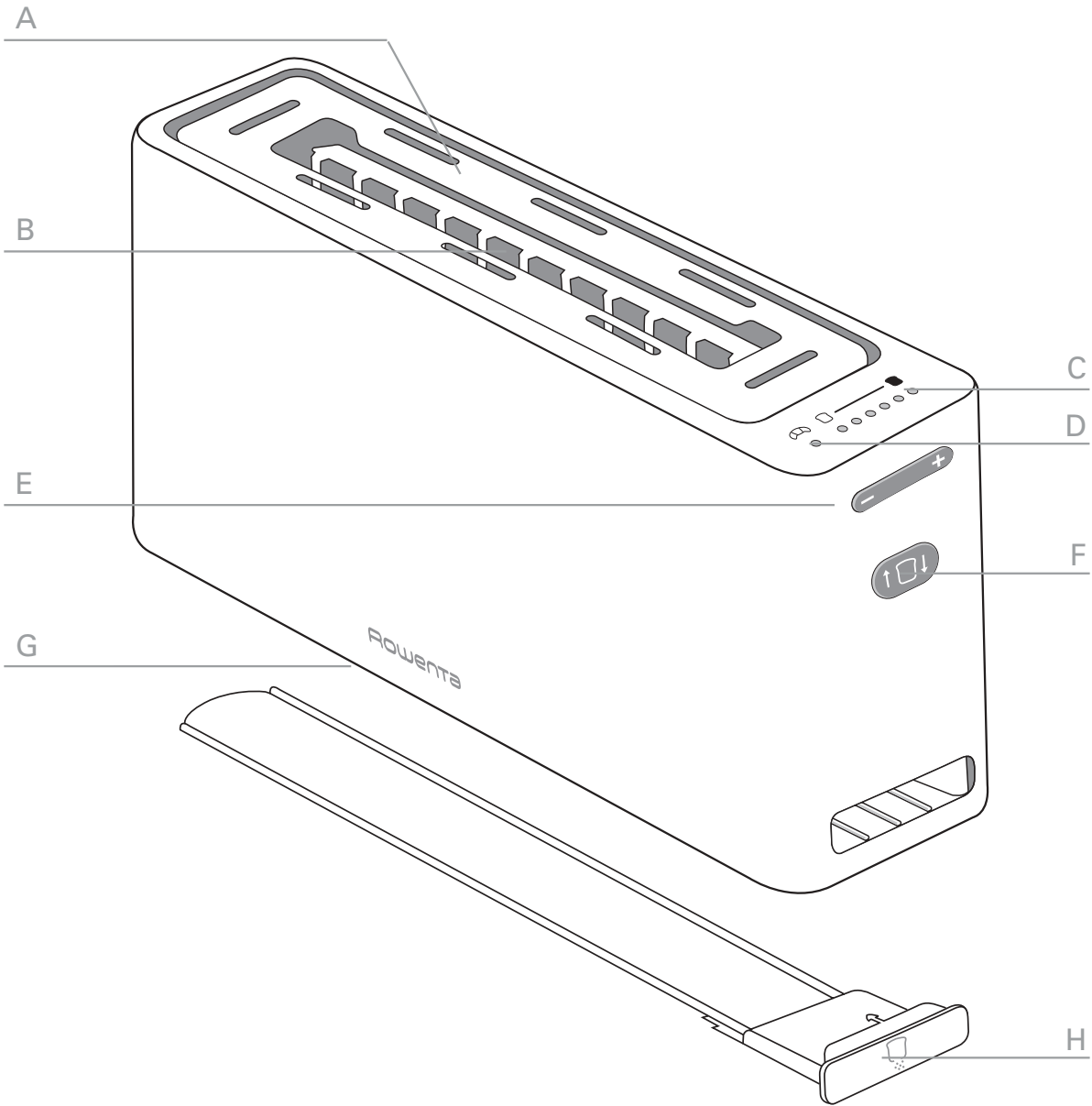

DESCRIPTION

- A Warming top
- B Toasting slot
- C Browning selection indicator light
- D Warming top indicator light
- E Browning control button
- F Start/stop
- G Cord storage (underneath)
- H Crumb tray

SAFETY INSTRUCTIONS (FOR EUROPE)

1 • To prevent any accidents:

This toaster complies with the safety rules and conditions in effect, and with the following directives

- Electromagnetic Compatibility Directive 89/336/CEE modified by Directives 92/31/CEE and 93/68/CEE.

- Low Voltage Directive 73/23/CEE modified by Directive 93/68CEE.

Check that the electricity supply voltage corresponds to the voltage indicated on the appliance (ac current only).

Given the many standards in effect, if this toaster is used in a country other than the country where it was purchased, have it checked by an approved service centre (see enclosed after sales service information).

Check that the electricity installation is sufficient to supply the power required by this appliance. Always plug the toaster into an earthed socket.

Do not let the cord hang over the edge of a work surface or come into contact with hot surfaces.

Do not store the cord or the plug between the slots in the appliance.

Do not unplug the appliance by pulling on the cord.

Use extension cords which are in good condition, with an earthed connection, and with a minimum rating of 10A.

In order to avoid electric shock, do not immerse the cord, the plug or the toaster in water or any other liquid.

Do not use metal utensils in the toasting mechanism, which could cause short circuits or electric shock (spoon, knife...).

Use a stable, heat-resistant work surface, away from any contact with water and never under cupboards or in a built-in kitchen alcove.

Do not move or carry the appliance when operating it.

2 • Important safeguards

When using electrical appliances, basic safety precautions should always be followed:

Do:

Carefully read and follow all the instructions of use.

The toaster must always be used in the upright position, never on its side or tilted forward or back.

Before each use make sure that the crumb tray is correctly into place. Regularly remove crumbs from the crumb tray.

Unplug from the power socket when not in use and before cleaning.

Allow to cool down before cleaning or storing it.

If the bread jams in the slots after toasting and the elements do not switch off, unplug the toaster immediately and wait for it to cool

before attempting to remove the bread.

Unplug the appliance if it shows any working abnormalities.

To disconnect remove the plug from the wall socket (when the toasting cycle is finished).

Do not:

The appliance is not intended for use by young children or infirm persons without close supervision.

Young children should be supervised to ensure they do not play with the appliance.

Do not let the toaster operate unattended, particularly when toasting for the first time or when changing settings.

Do not use the appliance for any other use other than that for which it was designed.

Do not touch the metal parts or hot surfaces of the appliance when it is working. Use handles or knobs.

Do not use accessory attachments that are not recommended by the appliance manufacturer as this may be dangerous.

Do not place any greasy or sugar coated type of bread in the toaster or anything that may melt or drop into the toaster as this may cause damage to the toaster or a risk of fire.

Do not try to toast very thick slices of bread that could block the toasting mechanism.

Do not use this appliance if:

- it has a damaged cord.
- the appliance has been dropped and has visible damage or does not operate properly.

In every case, the appliance must be sent to an approved after-sales service centre to avoid any risk of danger. Refer to the guarantee

enclosed.

Do not use outdoors. Avoid humid environments.

Do not place on or near a gas or electric burner or near a heated oven.

Do not store inflammable or explosive products near the toaster as bread can burn.

Bread can burn, therefore the appliance must not be used near or below curtains and other combustible materials such as curtains, drapes or wood (shelving, cupboards...) it should be attended when in use.

Never use the crumb tray on the reheating top.

Do not put dish, bowl, cup, feeding-bottle, plate, cooking paper or aluminium on the top or in the toaster

Do not put paper towels, cardboard or plastic in, on or under the toaster.

If flames were to arise from parts of the toaster, never attempt to extinguish them with water. Unplug the appliance and smother the flames with a damp cloth.

Do not attempt to dislodge food once the toasting cycle is engaged.

Do not use this appliance as a source of heating or drying.

Do not use the toaster for cooking, grilling or defrosting frozen food other than bread products.

Do not use the toaster for toasting bread and reheating pastries/croissants at the same time.

For your safety, never dismantle the appliance yourself. Send the appliance to an approved after-sales service centre (see enclosed leaflet).

This product has been designed for domestic use only. Any commercial use, inappropriate use or failure to comply with the instructions, the manufacturer accepts no responsibility and the guarantee will not apply.

3 • Save these instructions

USING THE TOASTER

ENG

1 • Before using for the first time

Unpack the toaster and remove any labels. Read the manual and carefully follow the instructions.

Unwind the supply cord completely.

NOTE Any bread protruding out of the slots will not be toasted.

Never leave toaster unattended during use. Use caution when toasting sugar coated or filled items (such as toaster pastries). Always set browning control to lowest setting.

Before toasting, be sure that toaster is not under cabinets or other flammable materials such as curtains.

Wipe the outside of the toaster with a damp sponge. Dry thoroughly. Plug in the toaster. When you plug in the appliance, the lever will automatically go up and down. When back in the up position, the toaster is ready to use.

NOTE On this motorized model, each time you plug in the appliance, or in case of an electrical power failure, the toaster will initialize.

Select the medium browning level by pressing on the browning control button – Fig 2
Press unto the start/stop button – Fig 3
Operate the toaster 1 or 2 times while empty to eliminate “that new smell”. Open a window.

2 • Helpful hints

Differences in moisture levels from one bread to another can result in varying toasting times and browning levels. Below are some general recommendations :

Slightly dry bread should be toasted on a

lower setting.

Very fresh bread or whole wheat bread should be toasted on a slightly darker setting. Breads with uneven surfaces, such as English muffins, may require a darker setting.

When toasting items with fruit, such as raisin bread or tea-cakes, remove any loose fruit before toasting. (raisins may fall into the appliance and create a fire hazard).

When toasting bagels, slice the bagel into two equal halves before toasting.

If you are toasting one slice of bread, set the browning control at a lower setting.

Use caution when warming or toasting sugar coated or filled items (such as toaster pastries).

Always set the browning control to the lowest setting.

3 • Inserting the bread

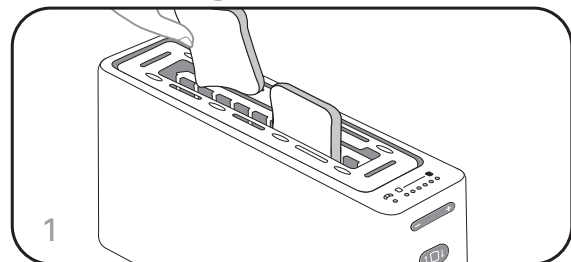

Place a slice of bread in the toasting slot – Fig 1.

4 • Toasting

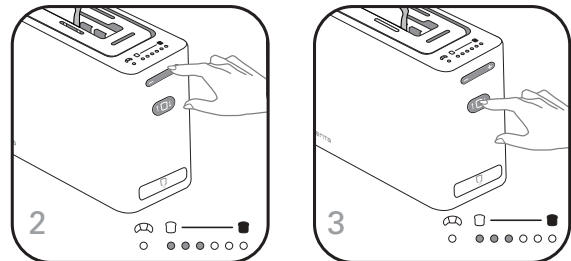

Select your desired toasting level by pressing the browning control button – Fig 2.

An indicator light will show your selection.

* depending on model

Press the start/stop button – Fig 3.

The toaster locks into the low position ; the bread slices are automatically centred for an even toasting on both sides.

For models with Photosensor system, you will always get the same level of browning. Whatever the type of bread (toast, baguette...) or its state of conservation (frozen, fresh, stale), the toaster will, on a selected position, provide the same level of browning, thanks to its sensors*.

Remove crumbs from the crumb tray after each use (toasting or reheating). To open the crumb tray, press on it once – Fig 10.

It is possible that the browning sensors* can be disturbed by external elements (e.g.: voltage...) or that browning is slightly different from one bread to another. If this difference is too significant, contact your local approved after-sales service centre (see enclosed list).

5 • To stop toasting

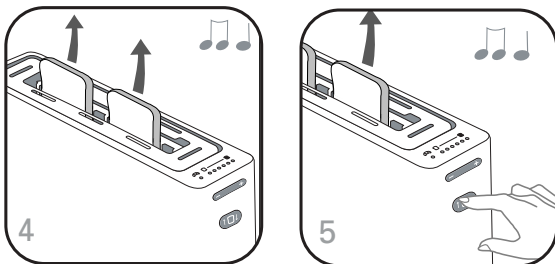

When toasting is complete, the bread control lever will unlock and the toasted slices of bread will pop up – Fig 4. A “BIP” alerts you. After 10 minutes of inactivity the appliance will automatically shut down, returning to the present settings for next use.

The toasting cycle may be interrupted at any time by pressing the « start/stop » button – Fig 5.

When a slice of bread is jammed, the appliance attempts to pop the slice up three times. If it fails, the appliance emits a “BIP”

several times. If this happens, press on the start/stop button, unplug the appliance and carefully remove the slice of bread.

6 • Reheat top

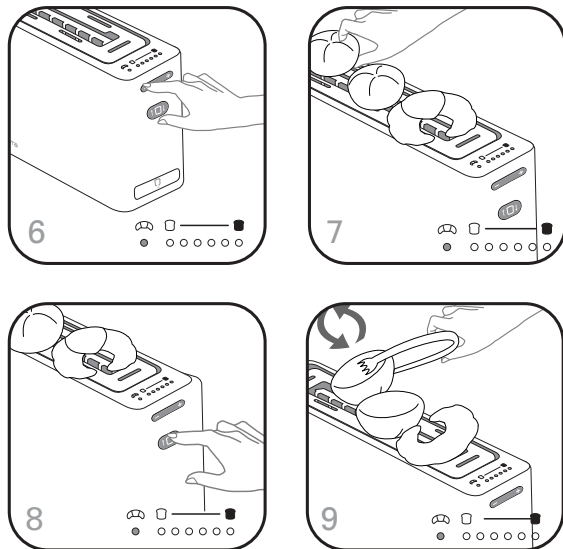

The warming top allows you to warm up bread rolls and croissants.

Press on the browning control button to position the indicator light on the reheat position  – Fig 6.

Put the rolls or the croissants directly on the reheat top – Fig 7.

Press on the start/stop button – Fig 8.

WARNING The warming top is extremely hot. Do not touch it.

The appliance starts and the heat diffuses through the top to reheat rolls and croissants thoroughly. Once the cycle is finished, to heat the other side, turn the rolls over with tongs or kitchen gloves if necessary (tongs and gloves are not provided with the appliance) – Fig 9. Do not press on the start/stop button, simply leave to warm for 1-2 minutes.

The reheat cycle may be interrupted at any time by pressing the « start/stop » button.

* depending on model

7 • Hints

When you do not use the toaster's full capacity, reduce the browning level and put the slice(s) of bread in the centre of the slots. Once the toasting is done, if the result is not satisfactory, reduce the browning level and press on the start/stop button.

WARNING Do not use the appliance to toast bread and warm rolls/croissants at the same time.
Do not use the reheat top to cook or defrost frozen food.

MAINTENANCE, CLEANING AND STORAGE

8 • Maintenance and cleaning

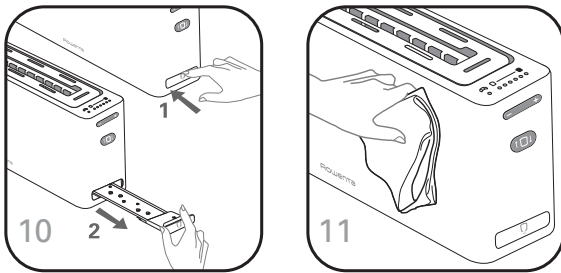

WARNING Before any maintenance, unplug the appliance and leave the toaster to cool down completely (around 15 minutes).

The toaster has browning sensors*. Clean the appliance regularly and handle it with care. Remove the crumb tray and discard the crumbs – Fig 10.

If pieces of bread or crumbs jam in the slots and in the heating elements, turn over the toaster opening downwards and shake it slightly to get them to fall out.

Put the crumb tray back into place. Check that it is correctly in place before each use. Do this after each use.

Never insert a metal object inside the toaster as this is dangerous and may cause serious damage.

* depending on model

Wipe the outside of the toaster and the cord with a damp cloth. Dry thoroughly – Fig. 11. Do not use bleach, abrasive or scouring cleaning products.

WARNING For the reheat top, never use metal (stainless steel, copper...) cleaning products. Use a soft cloth, or a damp sponge with washing up liquid. Never put the crumb tray in the dishwasher.

9 • Storage

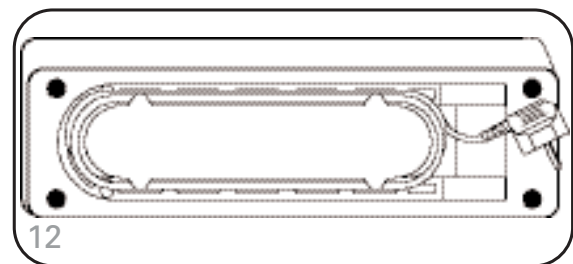

Always let your toaster cool down completely prior to storing. In a tightly enclosed space; heat may damage any type of inflammable material.

Do not wind the cord around the body of the toaster. There is a cord storage area underneath the appliance – Fig 12.

SAFETY INSTRUCTIONS (for USA and Canada only)

IMPORTANT SAFEGUARDS

When using electrical appliances, basic safety precautions should always be followed :

- 1 Read all instructions.
- 2 Never leave toaster unattended during use.
- 3 Keep out of reach of children.
- 4 Close supervision is necessary when the toaster is used by or near children.
- 5 Do not touch the metal parts or hot surfaces of the appliance when it is working. Use handles or knobs.
- 6 To protect against electrical shock do not immerse cord, plugs, or appliance in water or other liquids.
- 7 Unplug from outlet when not in use and before cleaning. Allow to cool down before cleaning and before putting on or taking off parts.
- 8 Do not operate any appliance with a damaged cord or plug or after the appliance malfunctions, or has been damaged in any manner. Return appliance to an approved Service Center for examination, repair, or adjustment, in order to avoid any risk of danger.
- 9 The use of accessory attachments are not recommended by the appliance manufacturer as they may cause injuries.
- 10 Do not let cord hang over edge of table counter or come in contact with hot surfaces.
- 11 Do not place on or near a gas or electric burner or near a heated oven.
- 12 Control lever must be in the "Up" position before attaching or disconnecting the plug from wall outlet.
- 13 Oversized foods, metal foil packages, or utensils must not be inserted in a toaster as they may cause an electric shock or fire.
- 14 Do not try to toast very thick slices of bread that could block the toasting mechanism.
- 15 If bread jams in the slots after toasting and the elements do not switch off, disconnect the plug immediately from the wall socket and wait for the appliance to cool before attempting to remove the bread. Do not attempt to dislodge food when toaster is plugged in.
- 16 Do not cover this appliance while in use.
- 17 Do not put paper towels, cardboard or plastic in, on or under the toaster.
- 18 There is a fire risk if the toaster is "covered" by, in contact with, close to or beneath flammable materials like curtains, drapes or wood.
- 19 Do not use outdoors. Avoid humid environments.
- 20 Do not use this appliance as source of heating or drying.
- 21 Do not use the toaster for cooking, grilling or de-frosting frozen foods other than bread products.
- 22 Do not use the toaster for toasting bread and re-heating pastries/croissants at the same time.
- 23 The toaster must always be used in the upright position (not on its side or tilted

forward or back).

24 Regularly remove crumbs from crumb tray.

25 This product has been designed for domestic use only. Any professional use, inappropriate use or failure to comply with the instructions will void the warranty.

Integrated warming plate :

Do not use the toaster without its warming plate.

Do not touch the warming plate as this will be hot. Use gloves or breadtongs if necessary.

Never place items other than bakery products on the warming plate or in the toaster.

Use caution when warming or toasting sugar coated or filled items as they can melt in the toaster.

Do not block or obstruct the air vents of the warming plate.

SPECIAL CORD SET INSTRUCTIONS

(a) A short power cord is provided, to reduce risks resulting from becoming entangled in or tripping over a longer cord.

(b) Longer extension cords are available and may be used if care is exercised in their use.

(c) If a longer extension cord is absolutely necessary :

1) The marked electrical rating of the extension cord should be at least as great as the electrical rating of the appliance.

2) The cord should be arranged so that it will not drape the countertop or tabletop where it can be pulled on by children or tripped over unintentionally.

(d) Do not unplug appliance by pulling on cord. Instead grasp plug and pull to disconnect.

(e) Never wrap cord around toaster. Use cord storage on the underside of unit.

PRODUCT IS FOR HOUSEHOLD USE ONLY.

SAVE THESE INSTRUCTIONS

ENVIRONMENT PROTECTION

The packaging of your product is recyclable. Do not dispose of it with the rest of your waste but rather recycle the packaging or bring it to your nearest recycling facility.

LIMITED WARRANTY

This Rowenta product is warranted for 1 year from date of purchase against defects in material and workmanship. During this period, any Rowenta product that, upon inspection by Rowenta, is proved defective, will be repaired or replaced, at Rowenta's option, without charge to the customer. If a replacement product is sent, it will carry the remaining warranty of the original product. This warranty does not apply to any defect arising from a buyer's or user's misuse of the product, negligence, failure to follow Rowenta's instructions, use on current or voltage other than that stamped on the product, or alteration or repair not authorized by Rowenta.

Repair or disassembly by anyone other than a Rowenta authorized service center will void the warranty. THE WARRANTIES SET FORTH HEREIN ARE EXCLUSIVE AND NO OTHER WARRANTIES, EXPRESS OR IMPLIED, INCLUDING BUT NOT LIMITED TO ANY WARRANTY OF MERCHANTABILITY OR FITNESS FOR A PARTICULAR PURPOSE OR USE, ARE MADE BY ROWENTA OR ARE AUTHORIZED TO BE MADE WITH RESPECT TO THE PRODUCT.

If you believe your product is defective, bring the product (or send it, postage prepaid) along with proof of purchase to the nearest authorized Rowenta Service Center (see below).

If you send the product, please include a letter explaining the nature of the claimed defect.

Rowenta Inc.
196 Boston Avenue
Medford, MA 02155
U.S.A.
Tel: (781) 396-0600
www.rowentausa.com

OFFICE LOCATION ONLY. FOR REPAIR INFORMATION SEE BELOW.

If your appliance needs service, ship the product to your nearest regional service center. Be sure to put your name on the outside of the shipping box. (No PO boxes please).

If in warranty, Rowenta will repair or replace the product at their discretion. If the product is out of warranty, you will be advised of the cost of repair before any work begins.

Our main service centers are listed below :

Turnpike Appliance
3495A Lawson Blvd.
Oceanside, NY 11572
516-483-5596

Authorized Appliance
1644 West Ogden Ave.
Downers Grove, IL 60515
630-852-1550

Service center information is subject to change.

If you have additional questions. Please visit our website at www.rowentausa.com. or call our consumer service at : 781.396.0600.

Call our service center information line at 781-306-4620 for current information and listings in California.